

HIGH TORQUE HYBRID STEPPING MOTOR SPECIFICATIONS

General specifications		Electrical specifications	
Step Angle (°)	1.8	Rated Voltage (V)	12
Temperature Rise (°C)	80 Max (rated current, 2 phase on)	Rated Current (A)	0.3
Ambient Temperature (°C)	-20~+50	Resistance Per Phase (±0%Ω)	40 (25°C)
Number of Phase	2	Inductance Per Phase (±20% mH)	20
Insulation Resistance (MΩ)	100 Min (500VDC)	Holding Torque (g.cm)	1300
Insulation Class	Class B	Detent Torque (g.cm)	120
Max. radial force (N)	28 (20mm from the flange)	Rotor Inertia (g.cm ²)	20
Max. axial force (N)	10	Weight (Kg)	0.21

● **Wiring Diagram:**

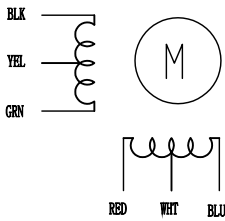

● **Pull out torque curve:**

VOLTAGE: 24VDC, CONSTANT CURRENT: WZM-2H042M 0.3A, HALF STEP

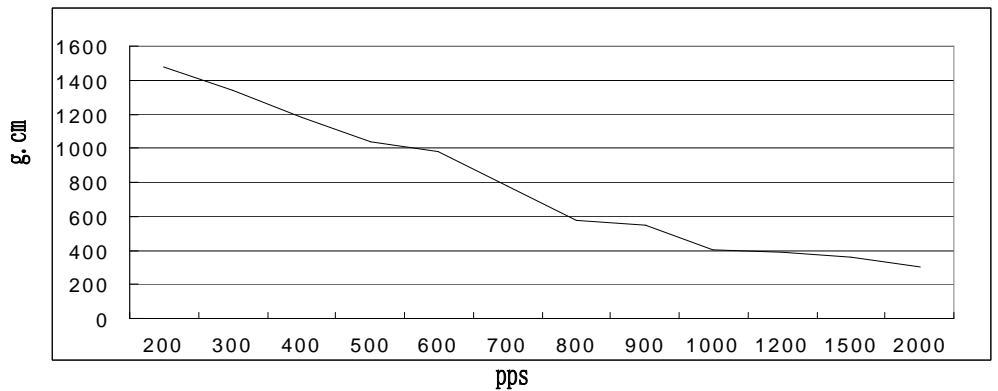

● **Dimensions:**
(unit=mm)

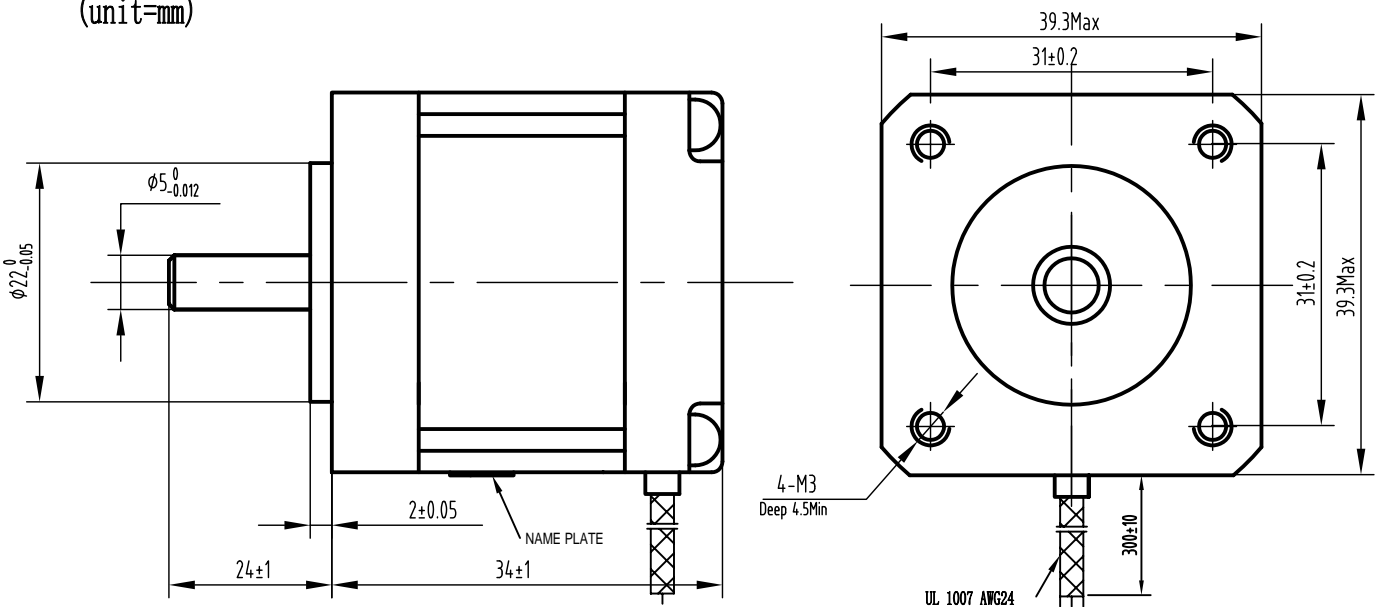

⚠						SY39ST34-0306A	TECHNICAL CONDITIONS
REV	REVISIONS	DESCRIPTION	BY	DATE	CHANGZHOU SONGYANG MACHINERY & ELECTRONICS NEW TECHNIC INSTITUTE		
DRAW							
CHECK							
APPROVE							