

HIGH TORQUE HYBRID STEPPING MOTOR SPECIFICATIONS

General specifications		Electrical specifications	
Step Angle (°)	0.9	Rated Voltage (V)	3.2
Temperature Rise (°C)	80 Max (rated current, 2 phase on)	Rated Current (A)	2.8
Ambient temperature (°C)	-20~+50	Resistance Per Phase(±0%Ω)	1.13 (25°C)
Number of Phase	2	Inductance Per Phase (±20% μ H)	5.6
Insulation Resistance (MΩ)	100 Min (500VDC)	Holding Torque (Kg.cm)	18.9
Insulation Class	Class B	Detent Torque (Kg.cm)	0.68
Max.radial force (N)	75 (20mm from the flange)	Rotor Inertia (g.cm ²)	480
Max.axial force (N)	15	Weight (Kg)	1.05

● Pull out torque curve:

VOLTAGE: 30VDC, CONSTANT CURRENT: 2.8A, HALF STEP

● Wiring Diagram:

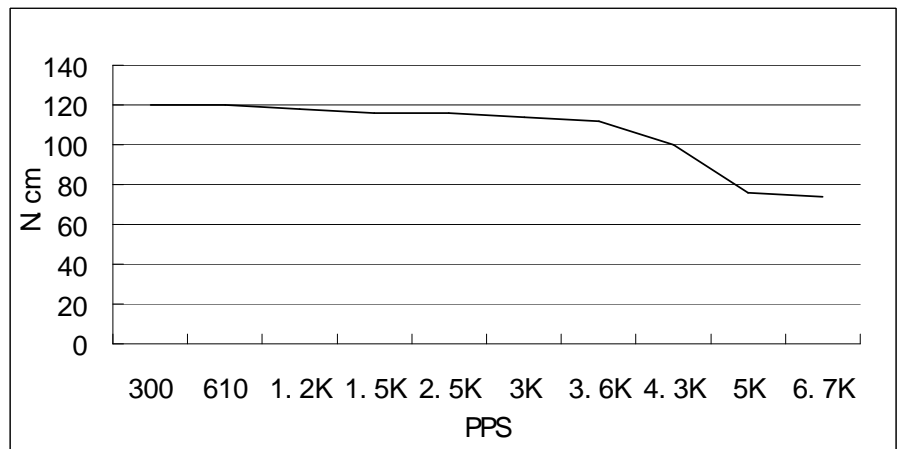
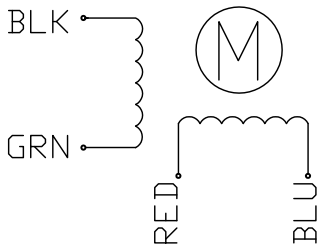

● Dimensions:
(unit=mm)

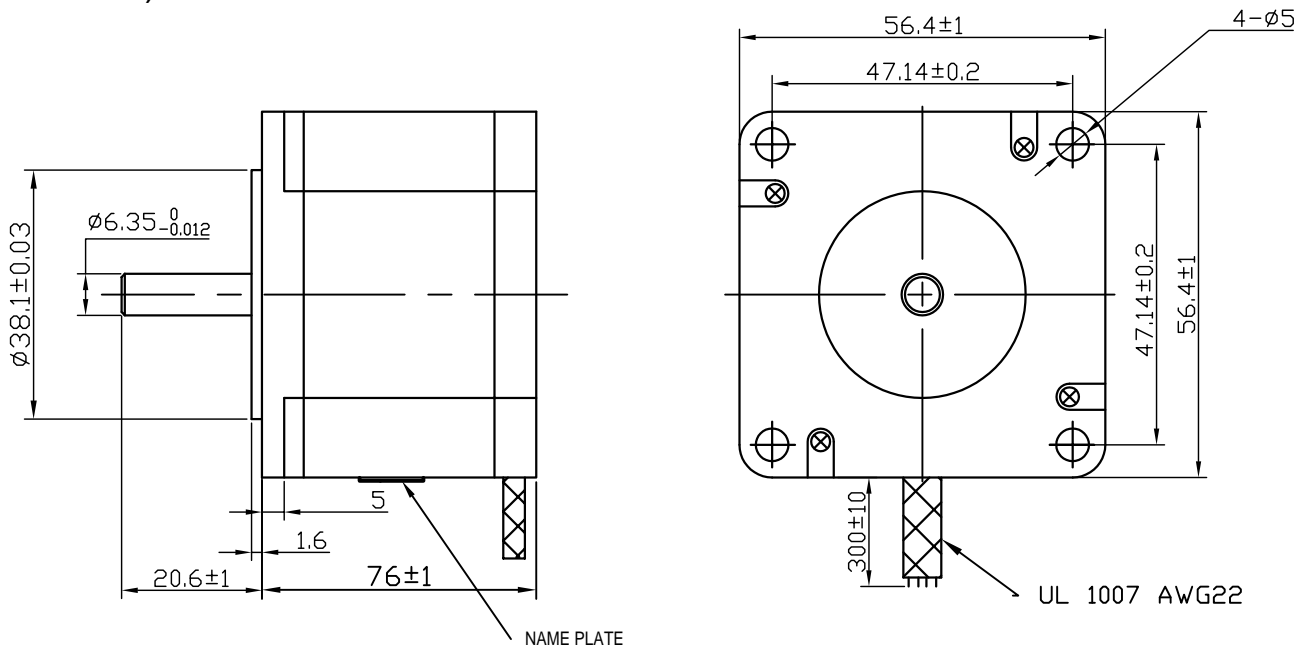

△					SY57STH76-2804MA	TECHNICAL CONDITIONS
△						
REV	REVISIONS	DESCRIPTION	BY	DATE	CHANGZHOU SONGYANG MACHINERY & ELECTRONICS NEW TECHNIC INSTITUTE	
DRAW	王凯					
CHECK						
APPROVE						